

PAPER • OPEN ACCESS

Power analyzer based arduino-uno validation using Kyoritsu KEW 6315 and Hioki 328-20

To cite this article: Sutisna *et al* 2019 *IOP Conf. Ser.: Mater. Sci. Eng.* **550** 012024

View the [article online](#) for updates and enhancements.

You may also like

- [Studying possible CP-violating Higgs couplings through top-quark pair productions at muon colliders](#)
Zenro Hioki, Takuya Konishi and Kazumasa Ohkuma
- [Optimal beam polarizations for new-physics search through \$t\bar{t}b\bar{b}\$](#)
Bohdan Grzadkowski, Zenro Hioki, Kazumasa Ohkuma et al.
- [Inductively Coupled Plasma Mass Spectrometry Study on the Increase in the Amount of Pr Atoms for Cs-Ion-Implanted Pd/CaO Multilayer Complex with Deuterium Permeation](#)
Tatsumi Hioki, Naoko Takahashi, Satoru Kosaka et al.

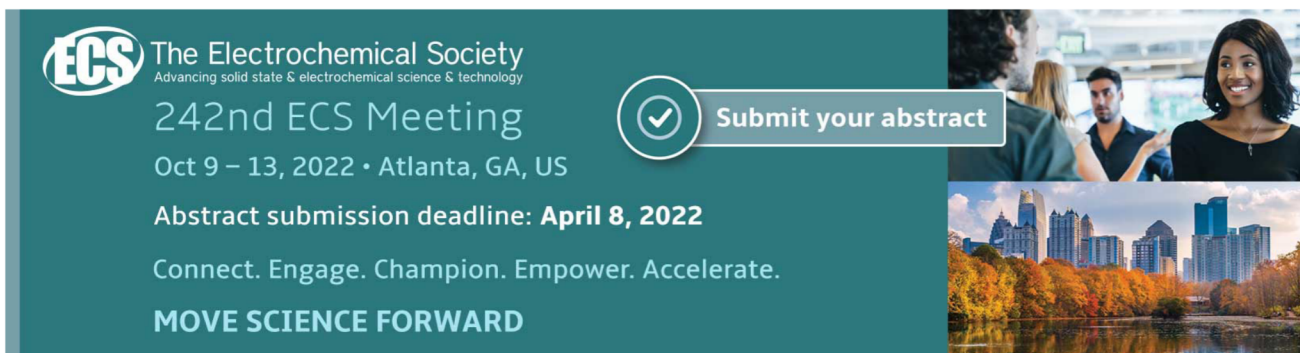

ECS The Electrochemical Society
Advancing solid state & electrochemical science & technology

242nd ECS Meeting
Oct 9 – 13, 2022 • Atlanta, GA, US

Abstract submission deadline: **April 8, 2022**

Connect. Engage. Champion. Empower. Accelerate.

MOVE SCIENCE FORWARD

Submit your abstract

The banner features a teal background with white text. On the right, there are two images: the top one shows a group of people in a professional setting, and the bottom one shows a city skyline with a lake and trees in autumn.

Power analyzer based arduino-uno validation using Kyoritsu KEW 6315 and Hioki 328-20

Sutisna, I Usrah, N Hiron and A Andang

Electrical Departement, Universitas Siliwangi. Tasikmalaya, Indonesia 46115

Email: sutisna@unsil.ac.id; ifkar_usrah@yahoo.com;
hiron@unsil.ac.id; andhangs@unsil.ac.id

Abstract. Online quality analysis technique of energy consumption is getting easier. It is because the sensor module and microprocessor are getting more simple, complex and possess high accuracy. This study offers an alternative to online electrical energy consumption monitoring technique by using Arduino. It is interesting to know the accuracy of the work of the Arduino-based energy quality monitoring system with high accuration measurments tool Kyoritsu power analyzer KEW 6315 and Hioki 328-20. The method of this research is the design of 1 phase electrical energy monitoring system by using current sensor type SCT-013 and voltage sensor in the form of transformer. EmonLib Library was used for processing voltage and current data in Arduino. The validation of measurement results was done by comparing the results of Arduino with Kyoritsu KEW 6315 and Hioki 328-20. The measurement reporting technique was displayed online based on the website. The results provide a clear picture of the measurement performance of the developed system, that the system has a quality of performance close to Kyoritsu type kew 6315 that against Hioki 328-20 with an average error below 5% is acceptable. The results of the measurement of electrical energy consumption had been successfully displayed in the form of a website-based energy report.

1. Introduction

The high demand for electrical equipment has caused the increasing use of non-linear loads. This increase of non-linear loads become one of the problems in electrical power quality [1]. Non-linear loads such as televisions, computer units, laptops, can generate high harmonics [2]. Poor power quality leads to high losses, sometimes leading to a voltage decrease in terms of electrical power users. Electrical equipment may be damaged due to voltage drop in the supply line [3].

Internet-based electrical power quality monitoring system based on internet technology becomes important because this system is not only accurate and fast but also can provide early warning of the decrease of electric power quality. The integration of internet technologies and the online monitoring of electric power quality makes it easy for human beings to make energy management decisions so that electric users can perform the routine behavioural evaluation of energy usage quickly and easily [4]. Therefore, online energy monitoring has the effect of changing people's behaviour in using electrical energy, to be more prudent in making decisions [5].

2. Methods

The purpose of this research is testing or validating the accuracy of energy measuring devices made with Arduino involving the voltage sensors transformer-based and current sensors SCT013 then comparing



the quality of the measurement with a measuring device manufacturing Kyoritsu KEW 6315 and Hioki 328-20.

2.1. Current sensor YHDC SCT-013

YHDC SCT-013 is a non-invasive sensor used as a measure of energy consumption [6]. The working principle of YHDC SCT-013 is by sensing (induced) induction of electric current and then dividing the current value to the number of coils on the sensor [7]. YHDC SCT-013 is capable of reading current from 0 to 13A consisting of 18000-turn coils with Non-linearity $\pm 3\%$ [8].

The YHDC SCT-013 current transformer is suitable to be used with the Open Energy emonTx [7]. Power quality variables, such as power factor and VAR power, can be determined from the phase change of the electric current. In this case, YHDC SCT-013 has an important role in dealing with such a task.

2.2. Electric energy consumption

Electric energy consumption consists of three primary variables as follows:

$$P = V_t \times I \times \cos \theta \text{ (Watt)} \quad (1)$$

$$S = V_t \times I \text{ (VA)} \quad (2)$$

$$Q = V_t \times I \times \sin \theta \text{ (VAR)} \quad (3)$$

P is the actual power required by the load in (Watt). S is the real electrical power supplied by the primary generator to the consumer in Volt-Ampere (VA). Q is the power produced by the load which is inductive in Volt-Ampere Reactive (VAR). The active energy consumption of the load can be obtained from equation (4).

$$W_a = P \times t \text{ (Watt - Hour)} \quad (4)$$

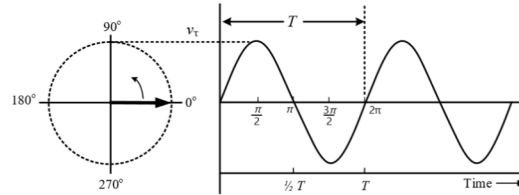

Figure 1. Sinusoidal of power characteristics.

Figure 1 illustrates the transformation of the sinusoidal waveform voltage (V_m) to the function of time into the form of angular frequency (ω). $V(t) = V_m \sin \omega t$. The function is repeated every 2π radian. Assumed that $V_m \sin \omega t$ is a function of t and the period is T , the period can be expressed in degrees' form in (8), and θ is $(\omega t + \theta)$.

$$f = \frac{1}{T} \quad (5)$$

$$\omega = 2\pi f \quad (6)$$

$$V_{(t)} = V_m \sin(\omega t + \theta) \quad (7)$$

There are some laboratory-scale power quality measuring instruments researches such as Kyoritsu KEW 6315 and Hioki 328-20. Kyoritsu KEW 6315 is a power quality measurement analyzer with measurement accuracy $\pm 0.2\%$ rdg $\pm 0.2\%$ f.s. (sine wave, 40 - 70Hz) [9], while Hioki 328-20 has Basic accuracy: $\pm 1.0\%$ rdg. ± 5 dgt [10]. Both of these tools are reliable measuring instruments manufactured in Japan.

3. Related work

In this paper, we offer a conventional voltage sensing technique by using linear transformers as conducted by [11-14]. Meanwhile, the sensors utilized was YHDC SCT-013 as already used in [14] and

[15]. Arduino Uno microcontroller and internet shield were used as data processing and communication interfaces between Arduino-Uno [16-17]. The communication network from the system to the server performed by using the 3G protocol.

EmonLib Library, which was downloaded from openenergymonitor.org, was used as a method of power calculation algorithms in Arduino as it is believed to be more straightforward and easier [13, 18-21]. Some studies have also introduced voltage sensing techniques by using low-voltage sensors that can integrate directly with microcontrollers such as ZMPT101B [22-26]. There is also research introducing voltage and current sensing techniques simultaneously in one tool for example with PZEM 004 module which is more practical than ZMPT101B.

This research aims to conduct a system testing on load in 2 conditional modes. The first condition was an offline mode in which the testing was done on the power panel for 1 hour. Then, the measurement results were observed and compared with Kyoritsu KEW 6315 and Hioki 328-20. The second was an online mode in which the system was connected to the internet for 30 days. The test was conducted on residential buildings with a total power load of 2200VA.

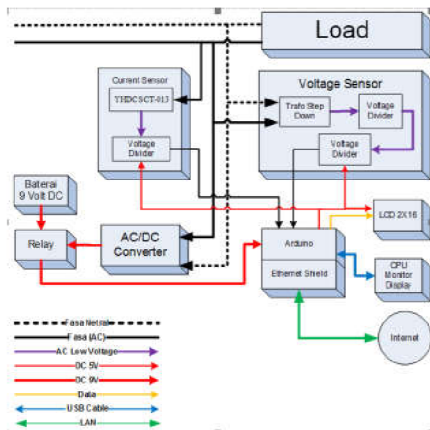

Figure 2. System architecture proposed.

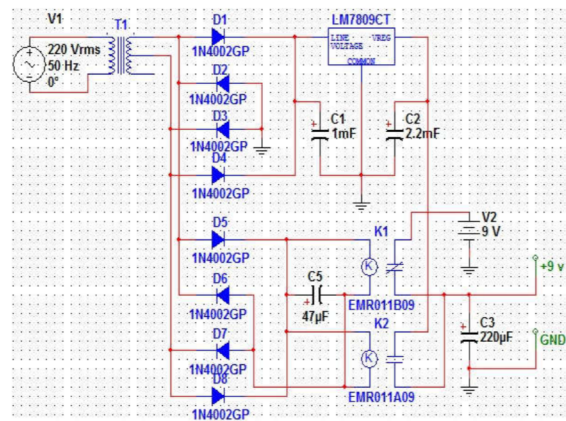

Figure 3. Circuit Scheme of backup power proposed.

Figure 2 is a system architecture, a complete architecture for energy monitoring with mobile web technology that has been discussed by Galera (2018) [27]. In this study, we have designed the architecture as shown in figure 2 where the dotted line is a neutral line, the black line is a single-phase AC 220V line voltage and the purple line is the low-voltage AC line. The red line is the DC 5V line voltage supplied from the main source and 9V supplied from backup power supply system. The yellow line is the digital data line, the blue line is the USB data path, the green line is the internet communication path using Local Area Network (LAN).

Figure 3 is a backup power supply scheme in which the input is obtained from a 220V main power and a 9VDC battery. If the main power supply is off, the power supply is switched from the battery without pausing.

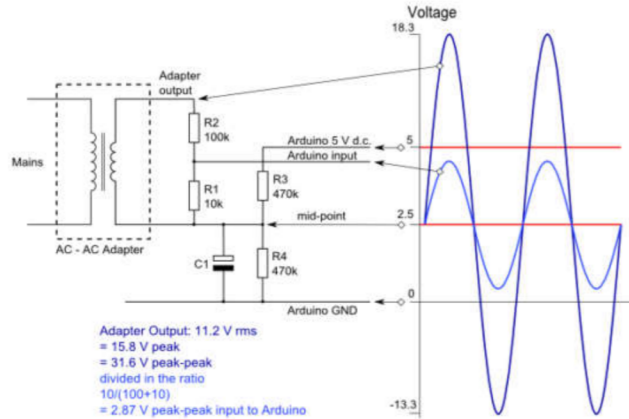

Figure 4. Line diagram of the voltage sensor using a step-down CT transformer [14, 15, 19].

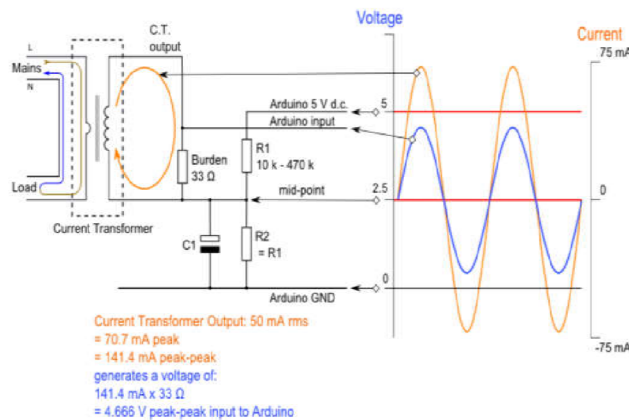

Figure 5. Line diagram of the current sensor using YHDC SCT-013 [14-15].

Figure 4 is the line diagram of the voltage sensor using a step-down CT transformer obtained from openeenergymonitoring.org. The 220VAC input voltage was reduced to a voltage of 18.3VAC. The voltage value of AC as input to Arduino was determined by an equation (1) with the range between 0V and 5V. Then, a 100 µF capacitor serves to decrease the ripple voltage. The midpoint is the median value of the voltage dynamics of the target which will be processed by the Arduino in Pin 2. The voltage divider dynamics to obtain the Arduino input and midpoint values was done by using equation (1) with the current value connected to Pin 1 Arduino. The same is true for electric current sensors, where the YHDC SCT-013 sensor was the current transformer (figure 5) using the EmonLib Library function that is calcIrms to find the RMS current value [18].

$$U_{out} = \frac{R_4}{R_3 + 4} U_p \tag{8}$$

4. Results and discussion

The result of the tests that have been done is to prove that the voltage sensor with transformer and current sensor that has been carried by previous researcher [11-14].

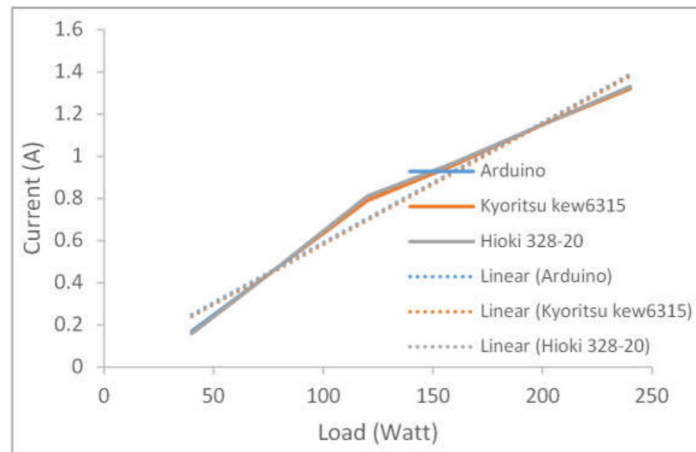

Figure 6. Testing of electrical current measurement system on linear loads.

The result of measurement test with linear loads in of heating elements was started from 40W to 240W with the power factor was assumed as 1 and then was compared with Kyoritsu KEW 6315 and Hioki 328-20 (figure 6). The Arduino-based measurement system showed results that resemble Kyoritsu KEW 6315 and Hioki 328-20. A nonlinearity occurred likely because there was a change in load resistance as a result of the heat that was held for a long enough period of time.

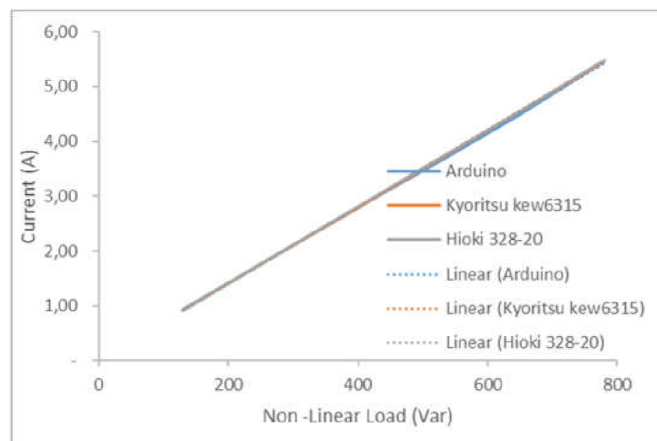

Figure 7. Testing of electrical current measurement system on Non-Linear Loads.

In the non-linear load test, some laptops from 130 Var to 780 Var with an average power factor of 0.65 were tested. The Arduino-based measurement system showed the same results as the measurement of electrical energy with Kyoritsu KEW 6315 and Hioki 328-20 (figure 7).

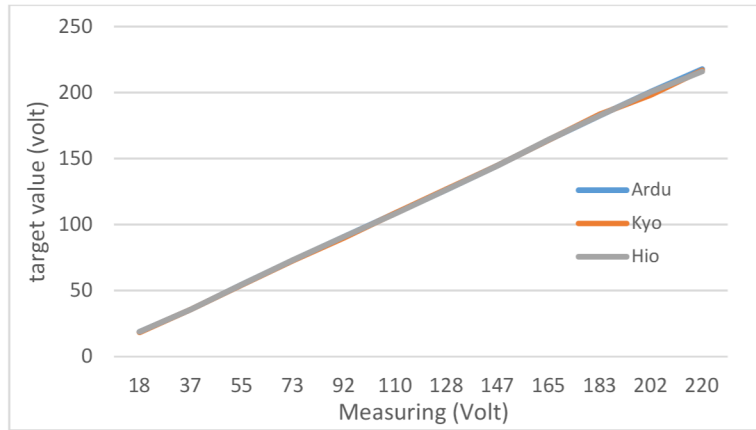

Figure 8. Testing of the accuracy of voltage measurement

The accuracy result of measurement error of the system against Kyoritsu KEW 6315 was 0.5%, while against Hioki 328-20 was 0.26%, see figure 8.

4.1. Offline system test

In offline testing on electrical power panel (figure 9) where the power measurement system with Arduino worked properly. Communication between current sensors and voltage sensors against Arduino could run normally. Table. 1 demonstrates the measurement error value of the system after it was compared with the other measuring instruments. In terms of voltage and current variables, the error value of the comparator was below 1%, while the error value of power factor and active power variables was below 2%.

Table. 1. Comparison of Arduino-based error measurement values against the other measuring instruments.

Parameter	Ardu vs Kyoritsu (%)	Ardu vs Hioki (%)
Voltage (V)	0.24	0.17
Current (A)	0.37	-3.44
Active Power (W)	1.89	-2.19
Power factor	1.33	-2.69



Figure 9(a). Testing wiring procedure of the measurements on the power panel.

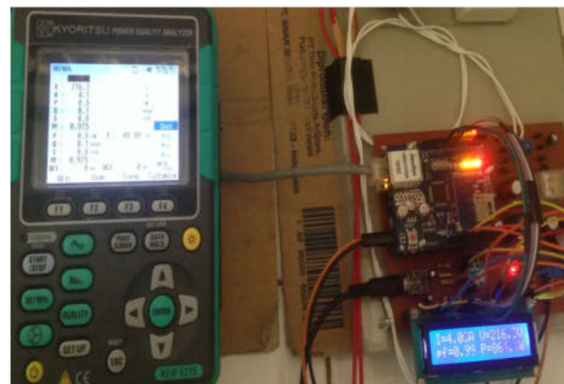

Figure 9(b). The comparison of measurement results.

Based on figure 11, the measurement results obtained between the system have been developed against the Kyoritsu kew 6315 and Hioki 328-20 as validator. Its found that they has the same characteristics in measurement. The average error of comparison between the Arduino and Kyoritsu for voltage measurements was 0.24%, while to the Hioki was 0.17% (figure 12). The average error of measurement of system based arduino against the Kyoritsu was 0.37%, while the Hioki was -3.44% (figure 12). The average error of comparison between the Arduino and Kyoritsu for power factor measurements was 1.33%, while against Hioki is -2.69% (figure 13). The average error of comparison between the Arduino and Kyoritsu for active power measurements was 1.89%, while the Hioki is -2.19% (figure 14). These results provide a clear picture of the measurement performance of the developed system, that the system has a quality of performance close to Kyoritsu type kew 6315 that against Hioki 328-20.

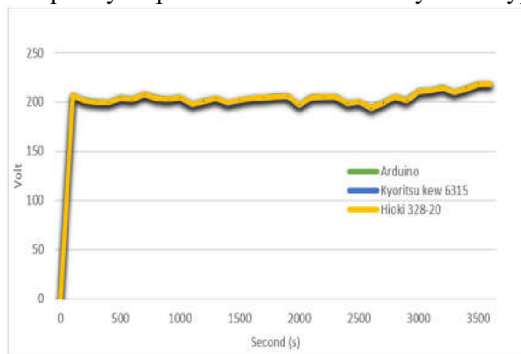

Figure 11. Voltage measurement value in comparison.

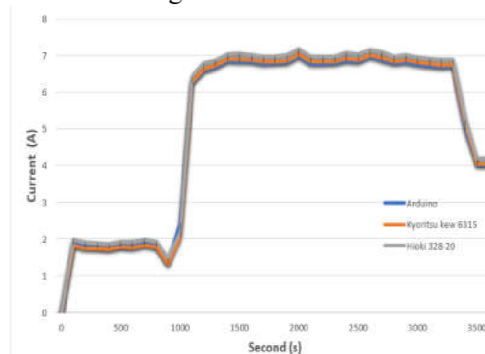

Figure 12. Current measurement capture in comparison.

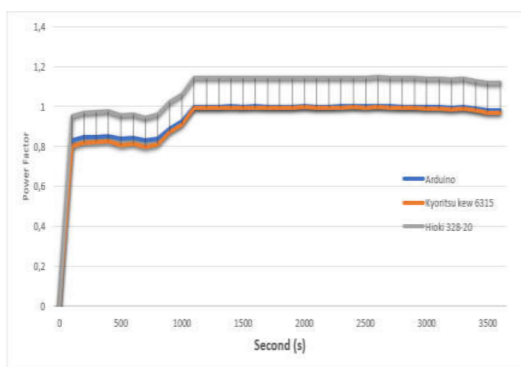

Figure 13. The power factor value measurements in comparison.

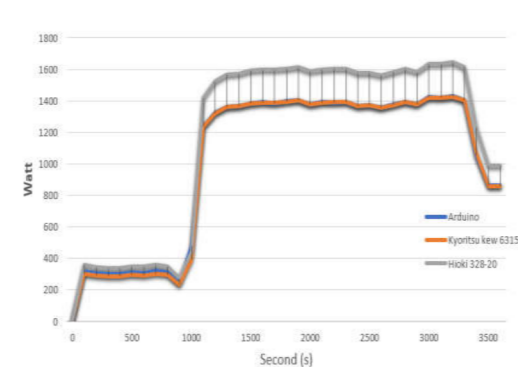

Figure 14. Active power measurement capture in comparison.

4.2. Online system test

The online system testing strongly depended on the reliability of the Internet network. Using a 3G communication network as a communication medium between the LAN Shield in Arduino and the server service had caused a delay in the data transfer from the sensors to the user display. The greater the delay in the data communications from the sensor to the server, the greater the measurement error occurred. This condition resulted in an inaccurate energy report although based on the offline test the measurement system showed accurate results. These results provide a clear picture of the measurement performance of the developed system, that the system has a quality of performance close to Kyoritsu type kew 6315 that against Hioki 328-20. The measurement system of electrical energy consumption that depends on internet service should be supported by reliable network quality. In other words, if the

electrical energy measurement system is implemented in the rural area, where the quality of the internet network is not guaranteed, a system failure might occur as if the whole system fails.

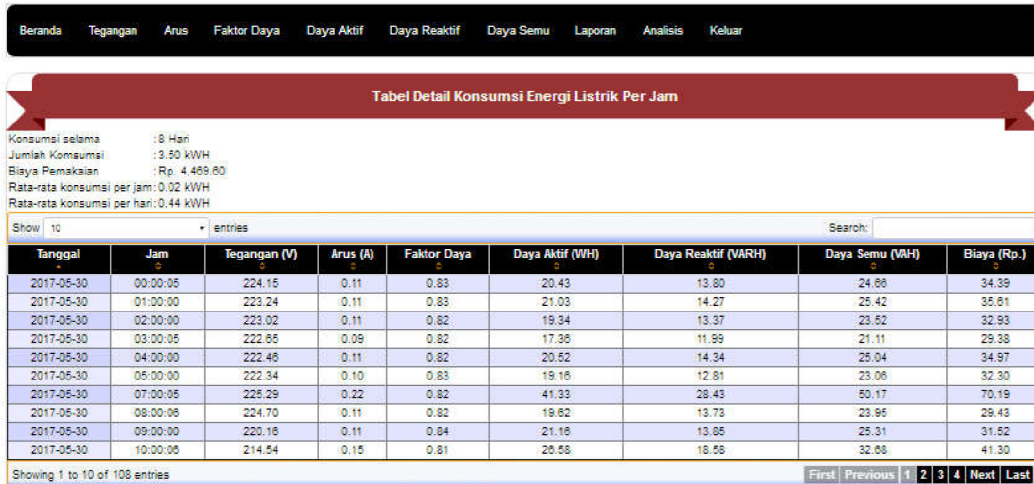

Figure 15. Power consumption in daily report dashboard.

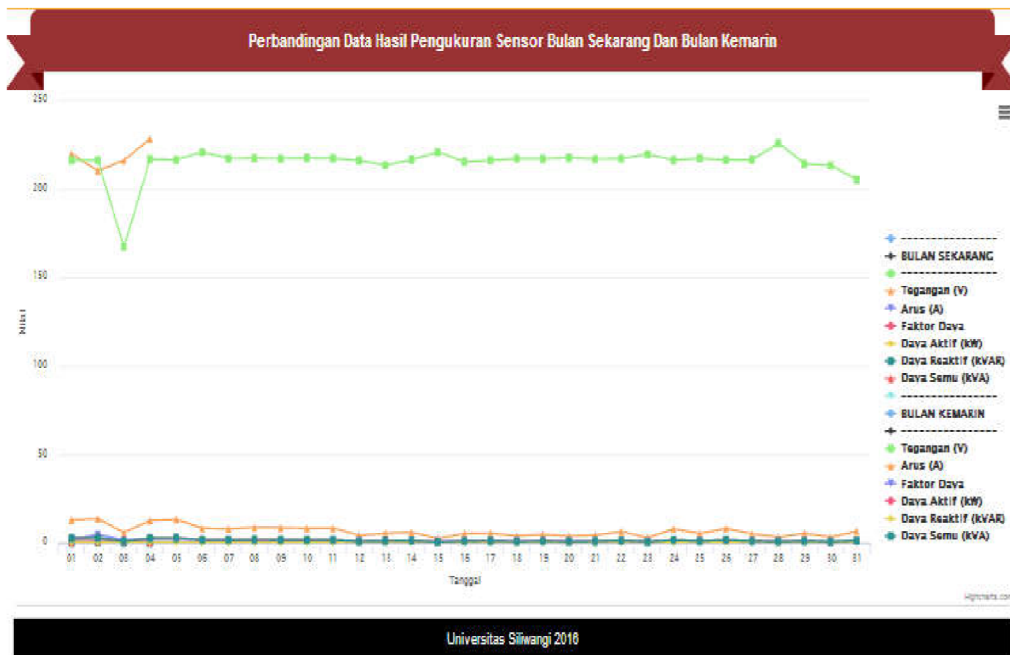

Figure 16. Power consumption in daily report chart.

5. Conclusion

Online energy monitoring system can be built by using Arduino which is cheaper and has good accuracy as well. The use of linear transformer-based voltage sensors depends on the quality of transformers. This study shows that the use of YHDC SCT-013 current sensors and voltage sensors with linear transformers resulted in good performance. It also reveals that communication through internet from sensors to server can be performed by LAN Shield module for Arduino. With an average error below 5% it can be said that an arduino-based energy measuring device that has been built can assume it is suitable for use as a

measure of electricity consumption. The test results both on offline and online conditions demonstrated satisfactory results. The communication between the Arduino and the server can run well as long as the internet network is available. Although the test results showed satisfactory results, it is essential to know if the energy monitoring sensors use multi-sensors on a 3 phase power network with a single server.

References

- [1] Yeotikar Ms A A and Mohod S B 2016 *IRJET* **3**(11) 581–4
- [2] Hiron N, Andang A and Mubarak H 2015 Energy Information System (EIS) As Energy Mix Projections with Trend Analysis Approach for The Scenario Achievement Of The National Energy Policy In 2025, in *The 14 International Conference on QIR*
- [3] Johnson D O and Hassan K A 2016 Issues of Power Quality in Electrical Systems *Int J Energy Power Eng* **5** (4) 148–154
- [4] Rajurkar A, Shinde O, Shinde V and Waghmode B 2016 *Int J Adv Res Comput Commun Eng* **5**(5) 398–400
- [5] Hiron N and Andang A Wireless communication with batching method based on Xbee-PRO S2B module for sensing of wind speed in *Proc - 2016 2nd Intl Conf on Sci Information Tech ICSITech 2016: Information Science for Green Society and Environment 2017* p 250–3
- [6] Pocero L, Amaxilatis D, Mylonas G and Chatzigiannakis I 2017 *HardwareX* **1** 54–67
- [7] Wall R 2014 A Report on the properties of the Yhdc Current Transformer and its suitability for use with the OpenEnergy monitor **6** 1–10
- [8] YHDC SCT-013-020 DATASHEET - Transformer 2017 [Online] Available: <http://www.datasheet4u.com/pdf/SCT-013-020-pdf/1089415> [Accessed: 15-Jul-2017]
- [9] Kyoritsu KEW 6315 | Power Quality Analyzer | PRODUCTS | KYORITSU [Online] Available: <http://www.kew-ltd.co.jp/en/products/detail/00100/> [Accessed: 15-Jul-2017]
- [10] Hioki AC Current Clamp Meter | Digital Clamp On HiTester 3282 - Hioki 2017 [Online] Available: https://www.hioki.com/en/products/detail/?product_key=6359 [Accessed: 15-Jul-2017]
- [11] Malagond G, Bagewadi G, Pooja L, Ronad B F and Jangamshetti S H 2015 Design and Development of Data Logger for Standalone SPV Systems *Int J Emerg Technol Adv Eng* **5**(5)
- [12] Kokatanur A S and Rao S K 2015 *IJRET* **4**(4) 2319–21
- [13] Murthy K V, Sriram P, Vignesh V, Suryaprakash C and Ranjankumar N 2017 Wireless Motor Monitoring and Controlling Through Visible Light Communication (Vlc) *SSRG Int J Electr Electron Eng* no March 76–81
- [14] Gwil Glyn Trystan Kate Claire and Amy Learn | OpenEnergyMonitor *openenergymonitoring* [Online] Available: <https://learn.openenergymonitor.org/electricity-monitoring/ct-sensors/interface-with-arduino?redirected=true> [Accessed: 24-Apr-2018]
- [15] M K Vishnu Murthy Sriram P Vignesh V Suryaprakash C and Ranjankumar N WIRELESS MOTOR MONITORING AND CONTROLLING THROUGH VISIBLE LIGHT COMMUNICATION (VLC) in *SSRG International Journal of Electrical and Electronics Engineering (ICRTECITA-2017)* 2017 no March pp 76–81
- [16] Hiron N, Andang A and H Setiawan 2016 Batch Processing Method in Machine to Machine Wireless Communication as Smart and Intelligent System *Int J Futur Comput Commun* vol **5**(3) 163–6
- [17] Hiron N and Andang A 2016 Wireless communication with batching method based on Xbee-PRO S2B module for sensing of wind speed in *2016 2nd International Conference on Science in Information Technology (ICSITech)* 250–3
- [18] Putra L, Michael, Yudishtira and Kanigoro B 2015 Design and Implementation of Web Based Home Electrical Appliance Monitoring Diagnosing and Controlling System *Procedia Comput Sci* **59** Iccsci 34–44
- [19] Rishav U and Tiwari M 2015 Automatic Power Factor Correction Using Capacitor Banks *IJREEICE* **3**(1) 86–9

- [20] Chishti M Z S 2018 Non-Intrusive Load Monitoring using Artificial Neural Network *Glob J Eng Technol Rev* **3**(2) 22–9
- [21] Nataliani R, Nugroho F X and Mursito E 2014 Pembuatan Perangkat Keras dan Analisis Sub-Metering Konsumsi Energi Listrik *J OTOMASI KONTROL INSTRUMENTASI* **6** (1) 25–35
- [22] Abubakar I, Khalid S N, Mustafa M W, Shareef H and Mustapha M 2017 Calibration of ZMPT101B voltage sensor module using polynomial regression for accurate load monitoring *ARPN J Eng Appl Sci* **12** (4)
- [23] Saputra W R, Muid A, Rismawan T and J S Komputer 2016 Rancang Bangun Sistem Monitoring Gangguan Pada Gardu Listrik Menggunakan Arduino Dan Website *J Coding* **4**(2) 141–50
- [24] David N, Anozie F N, Ebuka F O and Nzenweaku S A 2016 Design of an Arduino Based Wireless **7**(9) 466–9
- [25] V S B V M Design Of Wireless Power Meter For Overbilling Prevention Using Arduino
- [26] Mnati M, Van den Bossche A and Chisab R 2017 A Smart Voltage and Current Monitoring System for Three Phase Inverters Using an Android Smartphone Application *Sensors* **17**(4) 872
- [27] Galera K M E and Llantos O E 2018 Mobile Web Energy Monitoring System Using DFRduino Uno *Procedia Comput Sci* **124** 706–13

Acknowledgments

This research is a part of an external research program and is supported by research funding from KEMENRSITEK-DIKTI at the scheme Applied Product Research for the third year Thanks to LPPM-PMP Siliwangi University for supporting this project.